



Front Entrance Doors

RD80 & RD100

www.ryternaentry.com

RYTERNA

25 years delivering doors
with a personal touch!





RYTERNA Front Entrance Doors

Entrance door is a key element of house facade. Every day You see, touch and use it. Door must be safe, warm, maintenance free and match the exterior.

We offer wide range of made to measure and standard size doors with numerous design choices including possibility to create Your own design.

Latest technologies combined with perfect design results outstanding appearance and performance.



RD80 / RD100 designs	7
RD80 features	30
RD100 features	31
Features	32
Locking systems	34
Handles	36
Keypads	38
Finger scanners	39
Colours	40
Side and top elements	41
RD80 / RD100 design list	42





Design **229**
 Model **RD80 flush**
 Outside colour **RAL 9007 matt**
 Handle **H90S 1200mm stainless steel**
 Escutcheon **ESC-3**
 Windows **Safety triple glazing**
 Glazing **Matt**



Design **277**
 Model **RD80 flush**
 Outside colour **RAL 9007 matt**
 Handle **HLS4**
 Escutcheon **ESC-1**
 Windows **Safety triple glazing**
 Glazing **Matt**

Individual desgin



Design **264**
Model **RD80 flush**
Outside colour **RAL 7016 anthracite**
Handle **H90S40 800mm
stainless steel**
Escutcheon **ESC-1**
Windows **Safety triple glazing**
Glazing **Matt**







Individual desgin

Individual design



Design **228**
Model **RD80 flush**
Outside colour **White RAL 9016 matt**
Handle **H45R 800mm
stainless steel**
Escutcheon **ESC-3**
Windows **Safety triple glazing**
Glazing **matt**





Individual desgin



Individual desgin

Design **210**
Model **RD80 infill**
Outside colour **RAL 7012 matt**
Handle **H45R 500 mm**
stainless steel
Escutcheon **ESC-3**
Finger scanner **FSC3**
Windows **Safety triple glazing**
Glazing **Matt**



Design **223**
Model **RD80 flush**
Outside colour **RAL 4004 matt**
Handle **H45R 500 mm**
stainless steel
Escutcheon **ESC-3**
Windows **Safety triple glazing**
Glazing **matt**





Design **258**
 Model **RD80 flush**
 Outside colour **RAL 7016 matt**
 Handle **H90R 1200 mm stainless steel**
 Escutcheon **ESC-3**
 Windows **Safety triple glazing**
 Glazing **matt**



Design **220**
 Model **RD80 flush**
 Outside colour **RAL 9016 matt**
 Handle **H45R 500 mm stainless steel**
 Escutcheon **ESC-3**
 Windows **Safety triple glazing**
 Glazing **matt**

Individual desgin



Individual desgin



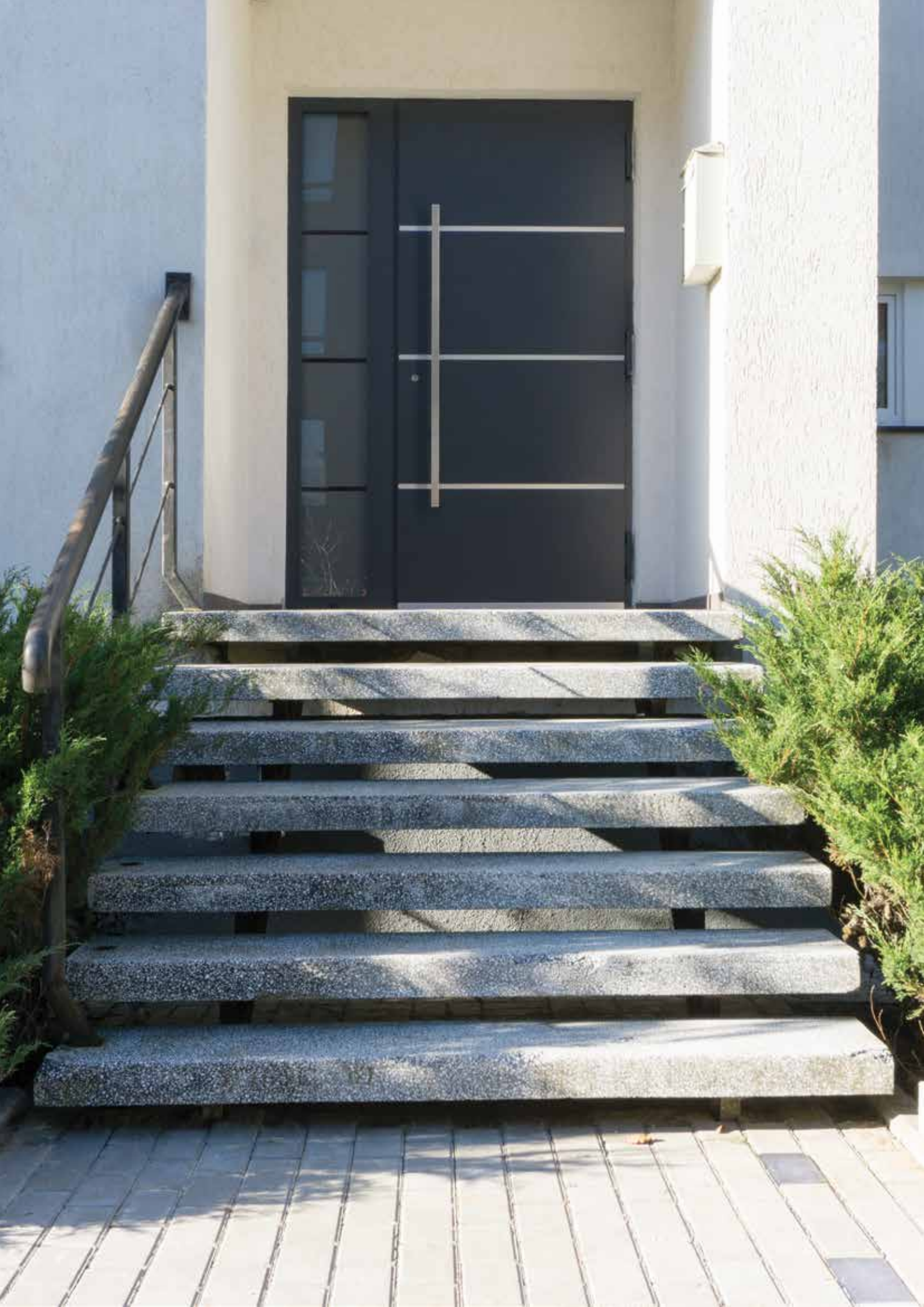



WELCOME



Design	220
Model	RD100 flush
Outside colour	RAL 7016 anthracite
Handle	H90S40 800 mm stainless steel
Escutcheon	ESC-3
Finger scanner	FSC3
Glazing	Etched effect



Individual design













Frame is made of aluminium profiles with thermal break. Leaf is with aluminium sheet skin. Leaf can be with infill panel or glass.
Thermal insulation - freon free PU foam.

All windows and sidelights are quadruple glazed with safety glass for flush doors. Triple safety glazing for infill doors. You can choose clear, obscure, opaque or tinted glazing options. Custom glazing available on request.

Ryterna entrance doors are made to resist the elements and certificated by IFT testing institute in Rosenheim, Germany.

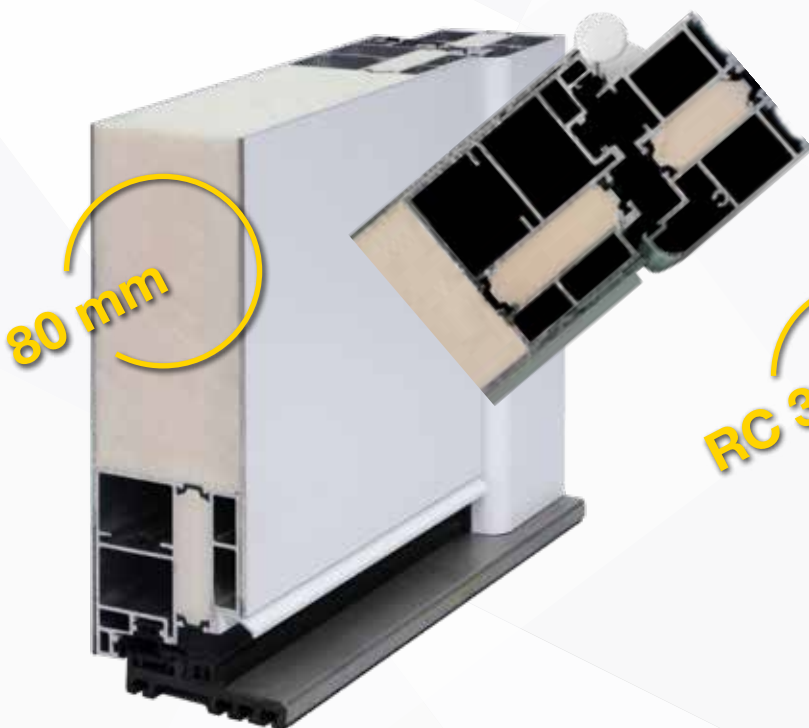

Thermal transmittance
U value



0.69 W/m²K

Safety resistance class
EN 12519



RC 3*

Wind resistance class
EN 12207:199-11



3

Rain resistance class
EN 12208:199-11



6A

Sound reduction
EN 717-1:2013



-32 Db

*for additional price, standard RC2

Frame is made of aluminium profiles with thermal break. Leaf is with aluminium sheet skin. Leaf can be with infill panel or glass.
Thermal insulation - freon free PU foam.

All windows and sidelights are quadruple glazed with safety glass for flush doors. Triple safety glazing for infill doors. You can choose clear, obscure, opaque or tinted glazing options. Custom glazing available on request.

Ryterna entrance doors are made to resist the elements and certificated by IFT testing institute in Rosenheim, Germany.

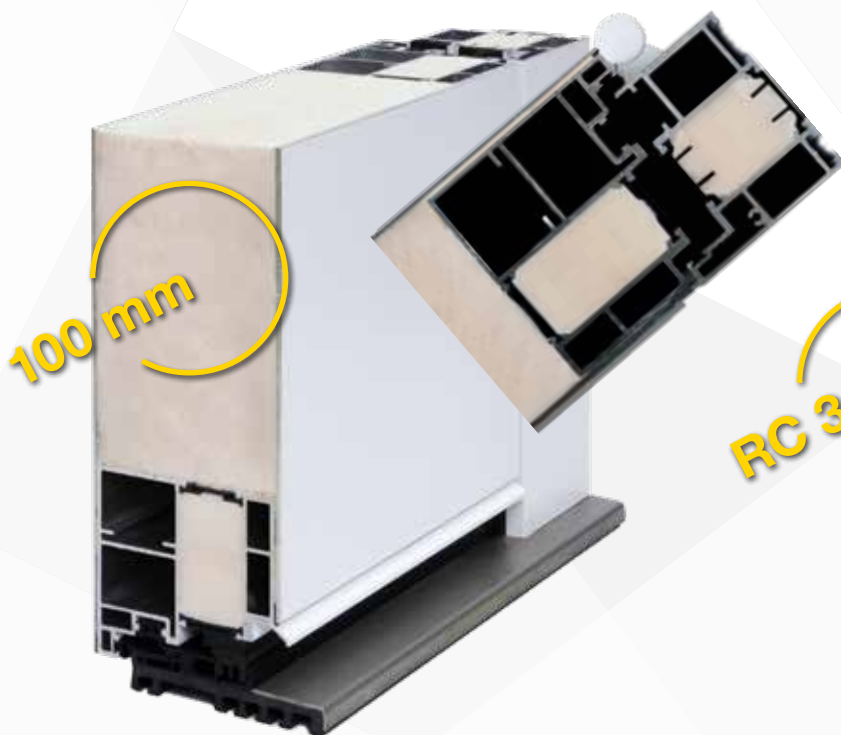

Thermal transmittance
U value



0.65 W/m²K

Safety resistance class
EN 12519



RC 3*

Wind resistance class
EN 12207:199-11



3

Rain resistance class
EN 12208:199-11



6A

Sound reduction
EN 717-1:2013



-32 Db

*for additional price, standard RC2

✓ Two types of frames

1. Flat
2. Jutted



✓ Two types of door leaves

1. Leaf with infill or glazing
2. Flush leaf with aluminium sheet skin

✓ Magnetic threshold

Door threshold has triple sealing and 'pop-up' magnetic seal. Hi-end durable and maintenance-free threshold system significantly improves insulation and is suitable for wheel-chairs. When you close the door magnetic seal pops-up and perfectly seal bottom gap between leaf and threshold. When opening the door you 'tear off' magnetic seal and it gently drops back in to its groove.

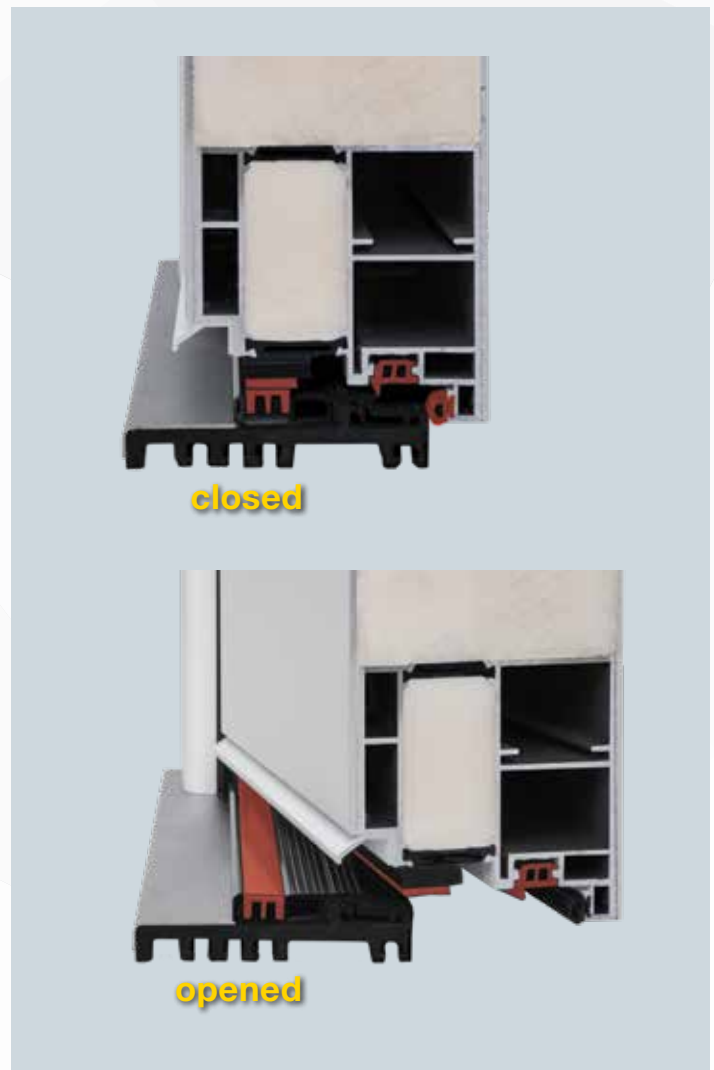

✓ Add-on bottom profiles

Available heights:
20 mm, 58 mm and 125 mm

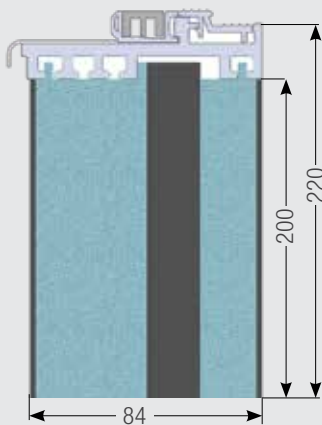
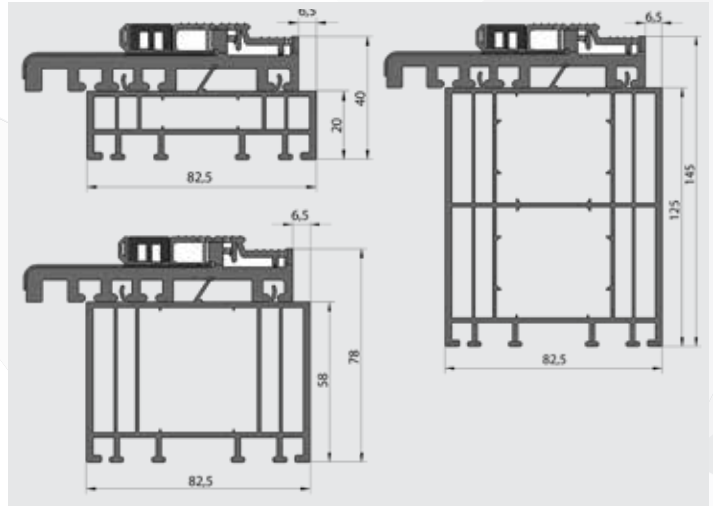

✓ Add-on bottom thermo profiles

Minimum height: 25 mm
Maximum height: 200 mm

✓ Key cylinders (safety classes A,B,C)

WILKA key cylinders are famous for their security and reliability. You can choose one of three safety classes: A,B or C the highest. WILKA cylinder comes with 5 keys. Additional keys are available on request



CWA



CWA+TT

✓ Partial opening lock

Available aluminium and white colours



POL

✓ Locks

KFV locks are made from high-quality materials with precise workmanship.

Hi-tech mechanics ensure reliable, precise and easy operation. Lots of options starting from the simplest 3 point lock up to sophisticated 5 point lock.

KFV



✓ 3 points multiple lock **L3P**

✓ 5 points multiple lock **L5P**

✓ Day & Night **L3P+D&N**

3 points multiple lock with option to disable temporary self-locking.

✓ Electric 1 **L3P+D&N+EM**

3 points multiple lock with electric strike and option to disable temporary self-locking.

Lock can be connected to finger-scan or keypad (optional)

✓ Electric 2 **L5PMA**

5 points multiple lock, latch-bolts are mechanically self locking and opening by electric drive, dead-bolt operated by key.

Lock can be connected to finger-scan or keypad (optional)

✓ Electric 3 **L5PA**

5 points multiple lock, Latch-bolts and dead-bolts are operated by electric drive.

Lock can be connected to finger-scan or keypad (optional)



L3P



L5P



L3P+D&N



L3P+D&N+EM

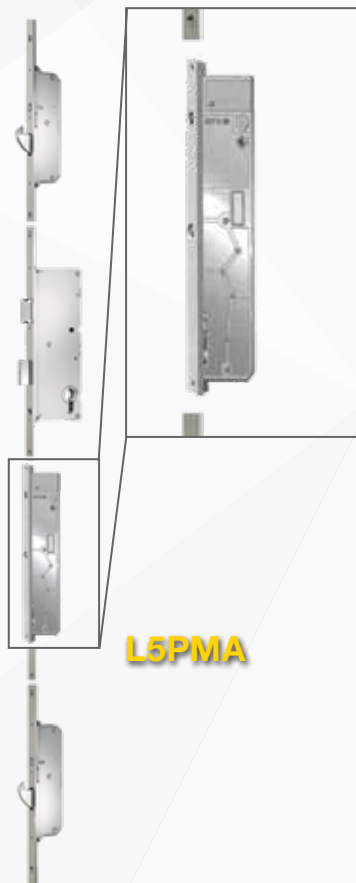

L5PMA

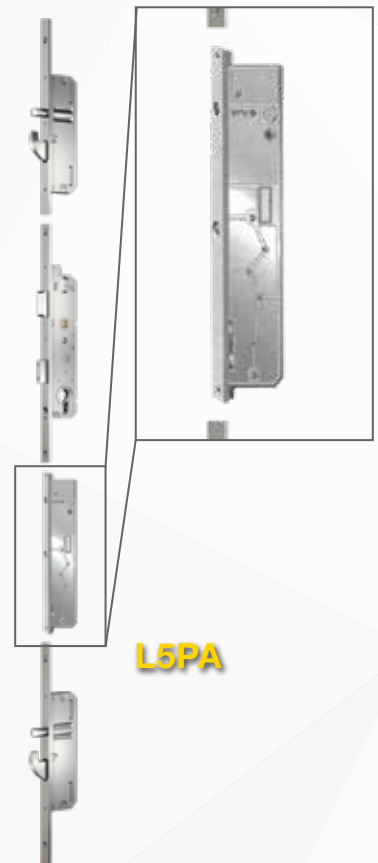

L5PA

✓ **Stainless steel handles**



H45R

Ø 30 mm
45°

Height available:

500 mm
800 mm
1200 mm
1400 mm
1600 mm



H45S

30x20 mm
45°

Height available:

500 mm
800 mm
1200 mm
1400 mm
1600 mm



H90R

Ø 30 mm
90°

Height available:

500 mm
800 mm
1200 mm
1400 mm
1600 mm



H90S

30x20 mm
90°

Height available:

500 mm
800 mm
1200 mm
1400 mm
1600 mm



H90S40

40x10 mm
90°

Height available:

500 mm
800 mm



H90S40B

40x10 mm
90°

Height available:

500 mm
800 mm



H90RB

Ø 30 mm
90°

Height available:

500 mm
800 mm



HRB

Ø 30 mm

Height available:

500 mm
800 mm

*Outside only

✓ Lever and knob handles



HL-W (White)



HL-B (Black)



***HK-W** (White)



***HK-B** (Black)



HLA (Aluminium)



HLS 01 (Stainless steel)



HLS 02 (Stainless steel)



HLS 03 (Stainless steel)



HLS 04 (Stainless steel)



HLS 05 (Stainless steel)



HLS 06 (Stainless steel)



HLS 07 (Stainless steel)



HLS 10 (White)



HLS 11 (Aluminium)



HLS 12 (Stainless steel)

*Outside only the rest can be fitted outside/inside

✓ Escutcheons

You can choose from five stainless steel escutcheons.



ESC-1



ESC-2



ESC-3



ESC-4



ESC-5
(Drill proof)

✓ **Keypads**

EKEY keypads are secure and easy to operate. Can contain up to 99 entries. Can be installed on door leaf or on wall.

Ekey White



KP2

Ekey Black



KP3



✓ Ekey Arte **FSC1**

Thanks to its compact design Arte finger scanner can be integrated discreetly into unusual door designs and fittings.

✓ Ekey Integra **FSC2**

The finger scanner is mounted in the wall using stainless-steel accessories (in-wall set).

The finger scanner will only operate when connected to an ekey control panel.

Both finger-scanners can be controlled by app. So you can open the door with your smart-phone and enjoy all the benefits of operation via app.



FSC1



FSC2

✓ Sommer finger scanner **FSC3**

Secure and easy to operate Sommer finger-scanner will bring more convenience in to your everyday life.

By entering your own 3 fingerprints you can easily operate entrance, garage doors and gate. Just with three touches you can close gate, garage door and open entrance door or vice versa.

✓ Sommer remote handset **RMT1**

Sommer finger-scanner and remote handset are compatible with each other. 4 channel handset can operate 4 different objects like entrance or garage door, gates or yard lights.

Secure rolling code transmitter signal can not be copied. Just one beautifully crafted ergonomic handset can replace a bunch of keys.



FSC3



RMT1

✓ Inside RAL colours

- RAL 9016 gloss 20%
- Any colour from Ryterna official RAL palette

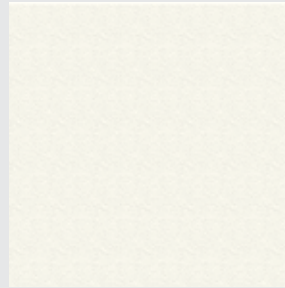
**RAL 9016 gloss****Ryterna RAL palette****✓ Outside RAL colours**

- RAL 9016 gloss 20%
- RAL 7016 gloss 20%
- RAL 7016 structure
- Any colour from Ryterna official RAL palette

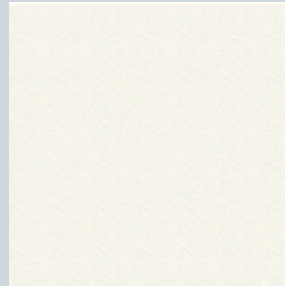
**RAL 9016 gloss****RAL 7016 gloss****RAL 7016 structure****Ryterna RAL palette**

✓ Side and top elements

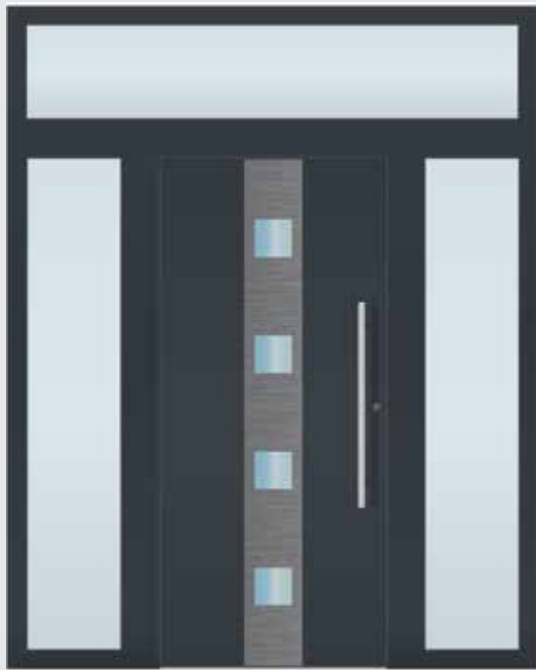

LRW



RW



LW



TW



TLRW



TLW



TRW

✓ Glazing options



Clear **SGC**



Tinted **SGT**



Matt **SGM**



Patterned **SGP**

✓ Etched effect glazing



For design possibilities and price consult the manufacturer.



200

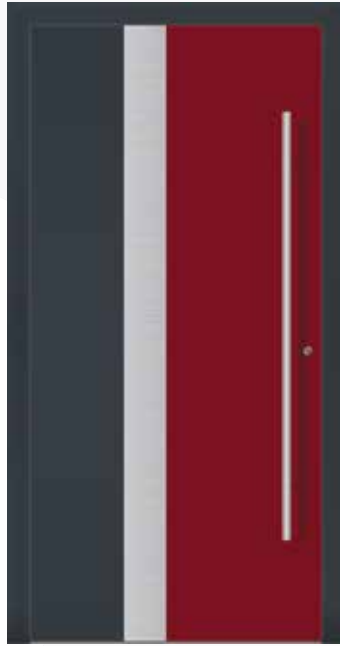

201



202

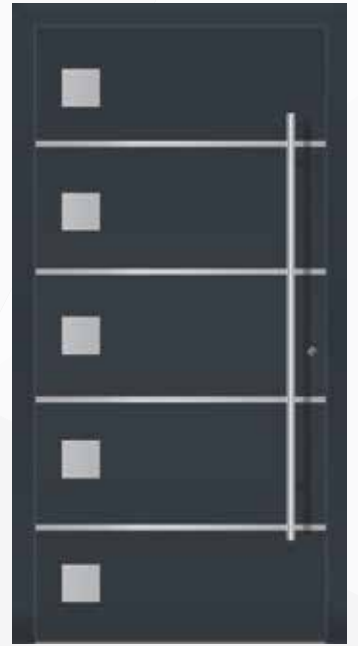

203



208



209



210

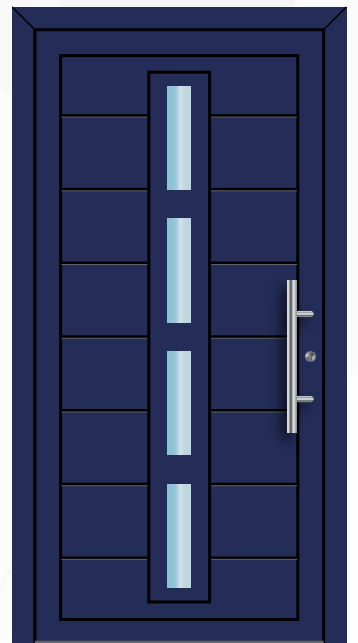

211



204



205



206

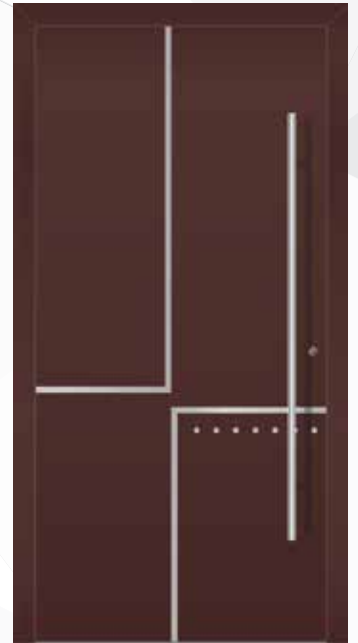

207

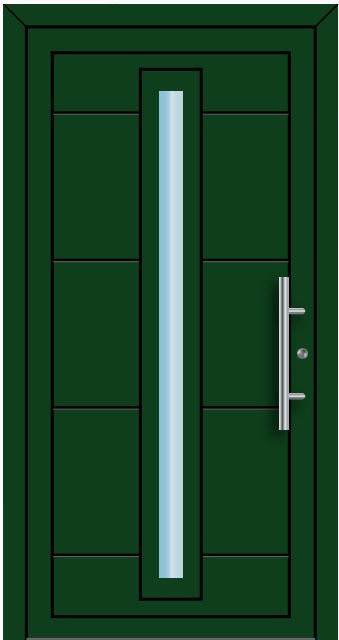

212



213



214



215

* you can modify existing or create your own door design



216



217

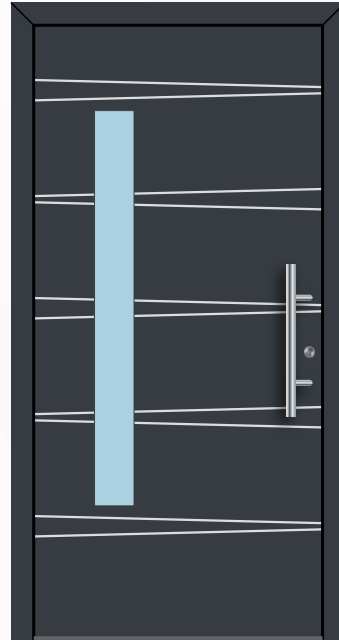

218

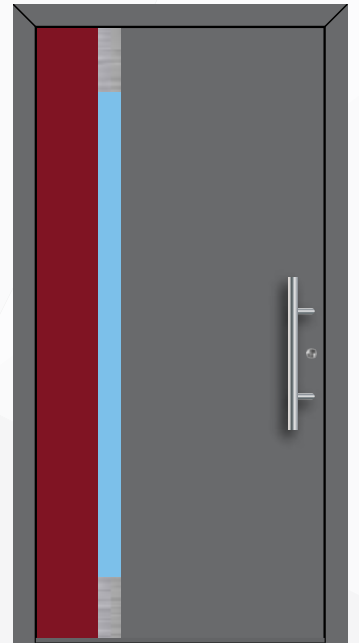

219

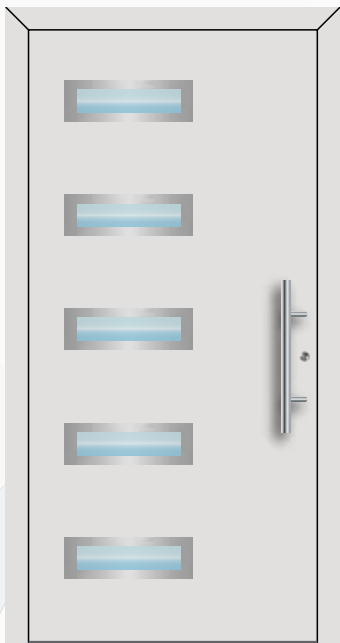

224

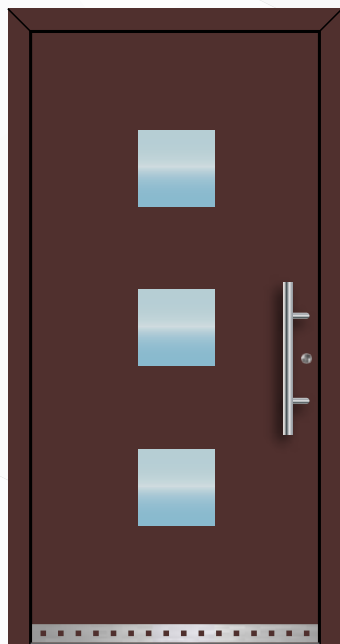

225

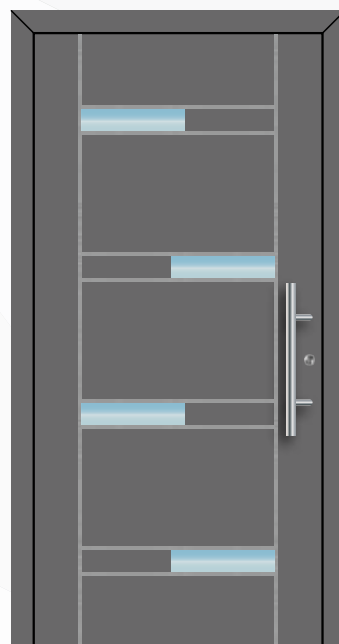

226

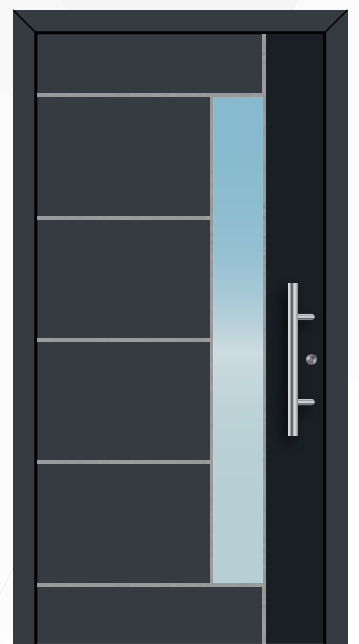

227



220

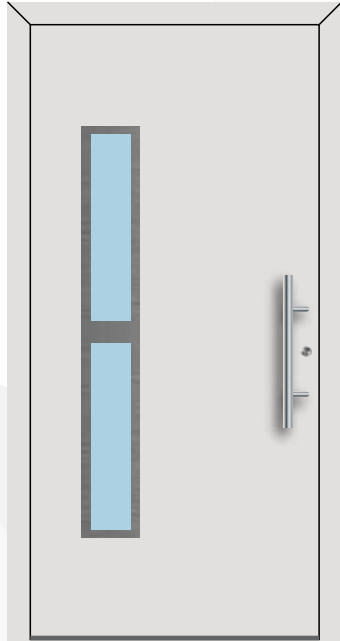

221

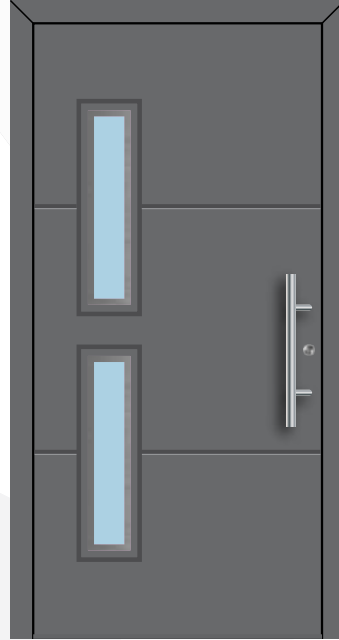

222

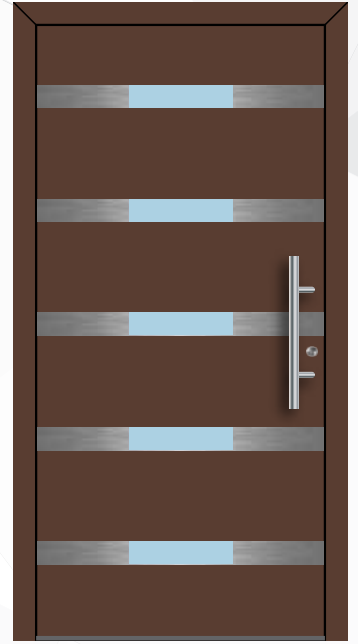

223



228



229

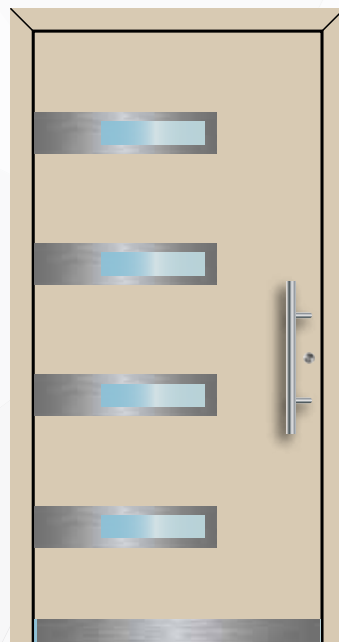

230

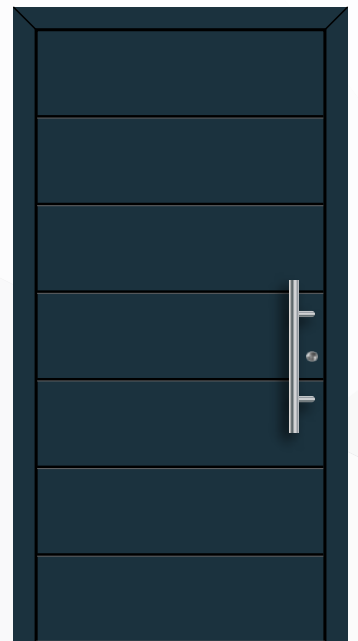

231

* you can modify existing or create your own door design

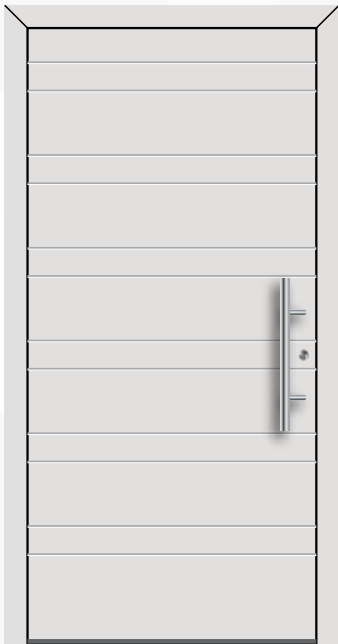

232



233

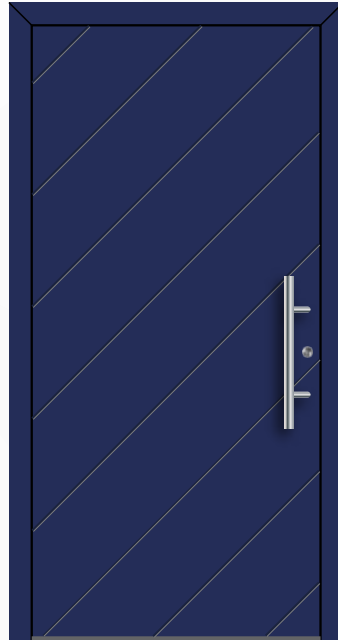

234



235

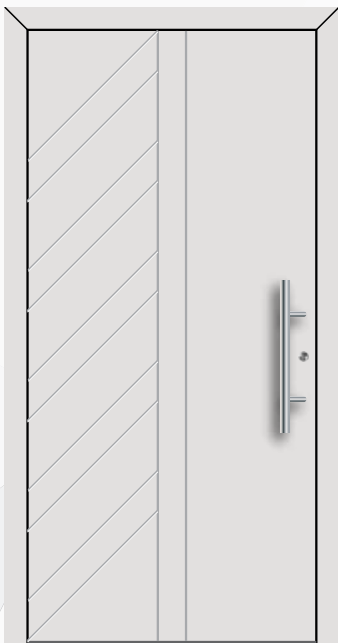

240



241



242

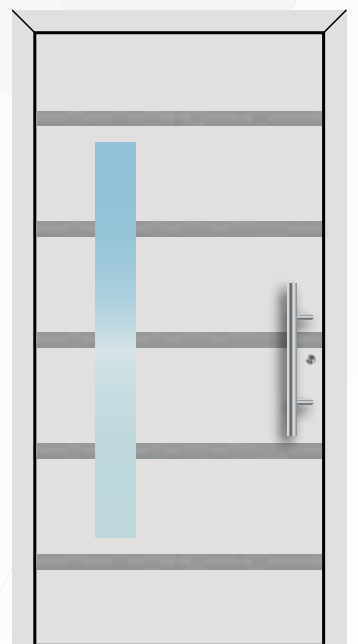

243

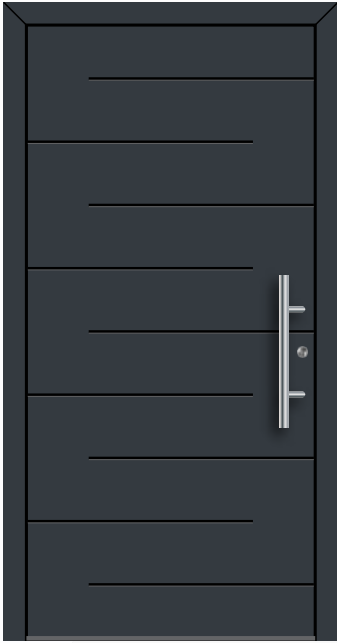

236



237

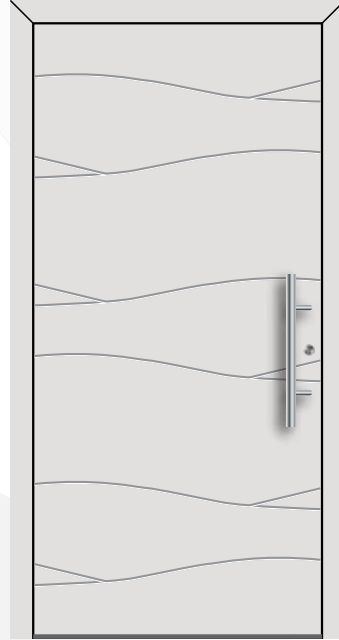

238

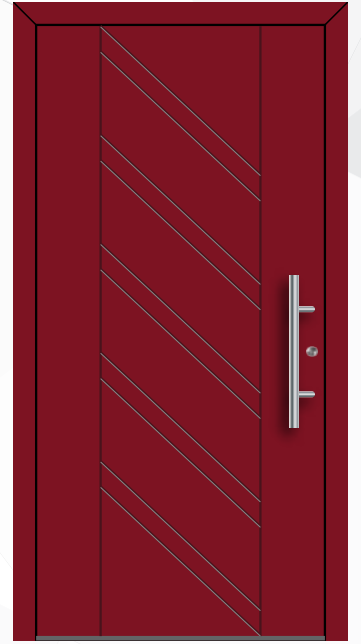

239

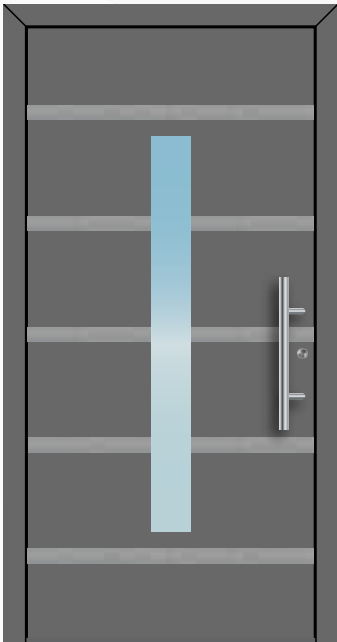

244

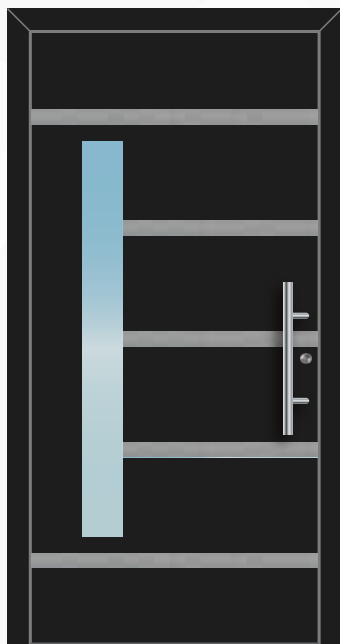

245

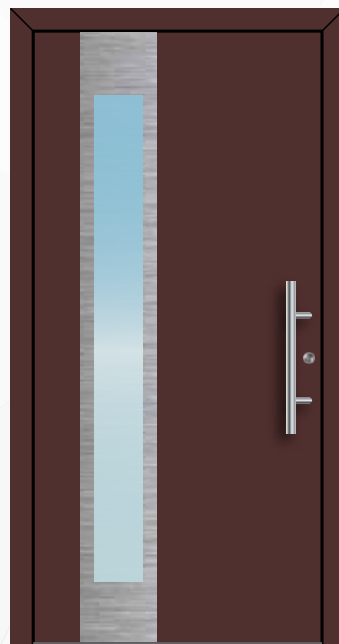

246

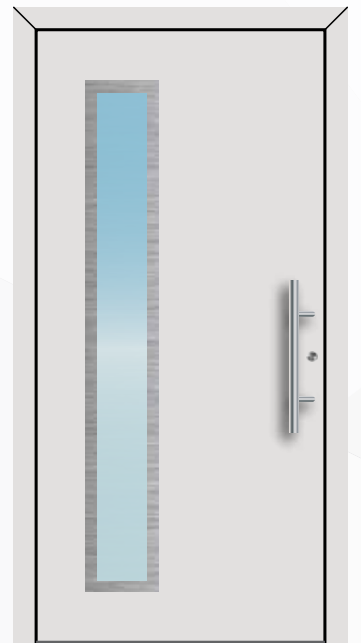

247

* you can modify existing or create your own door design

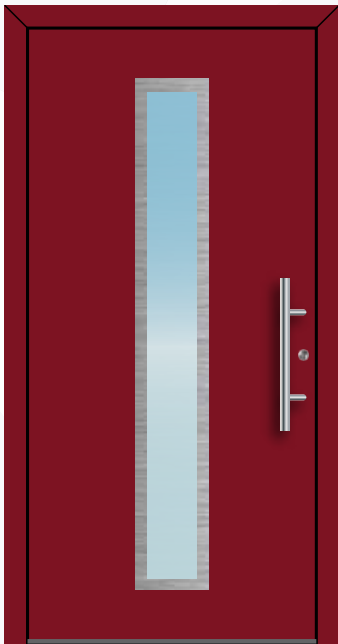

248

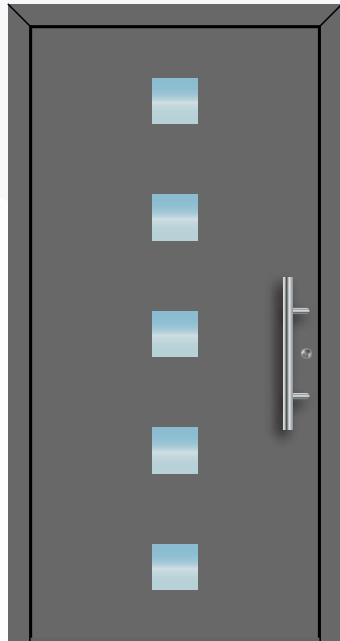

249

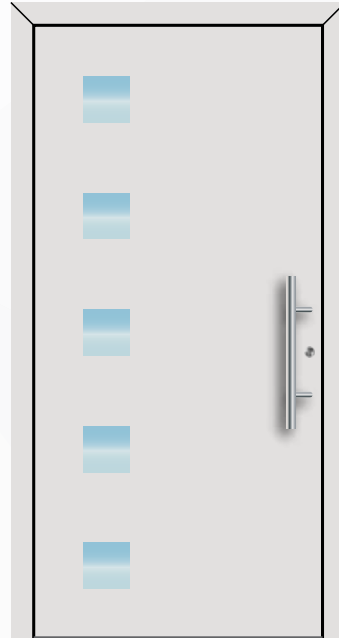

250

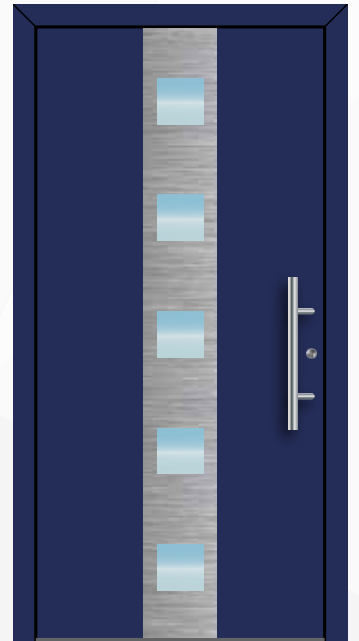

251

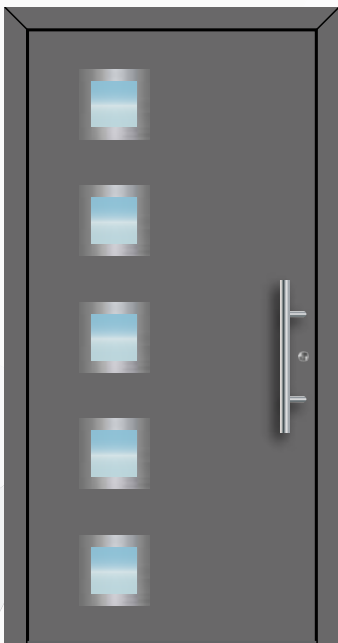

256

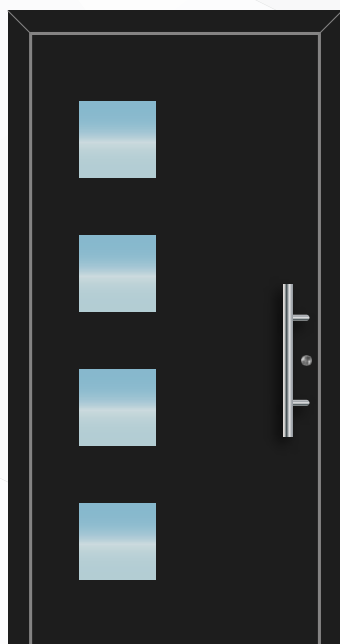

257

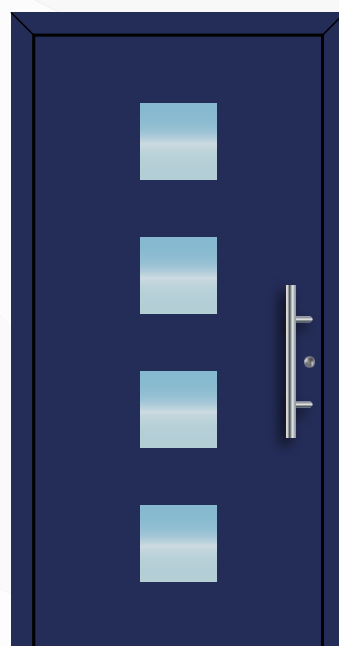

258

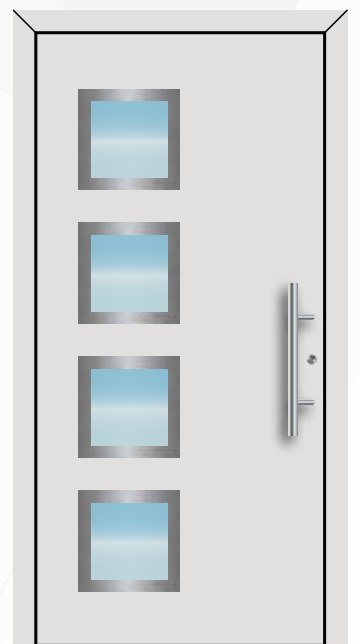

259

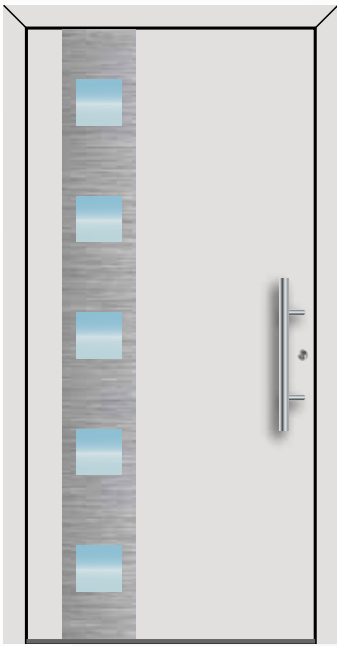

252

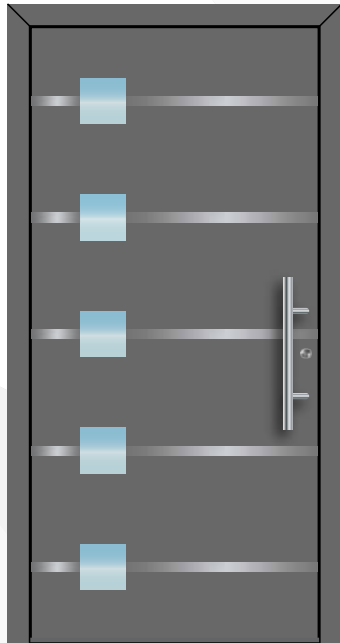

253

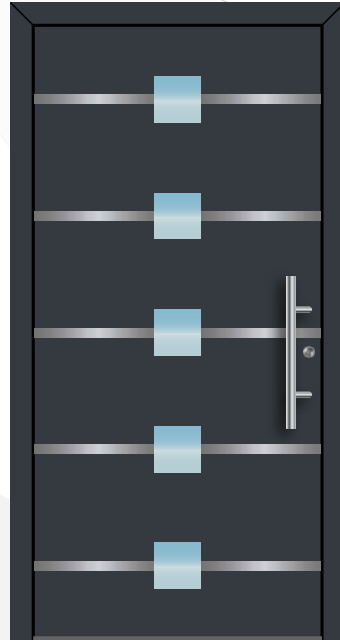

254

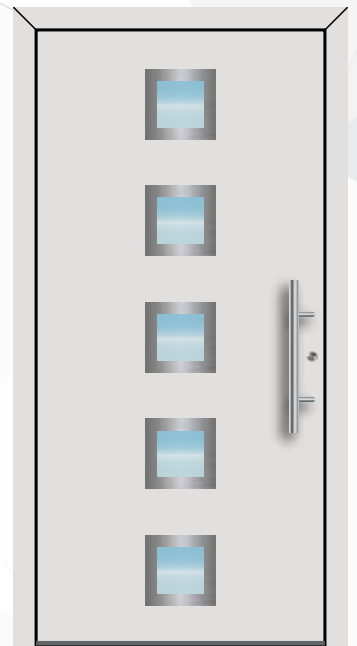

255

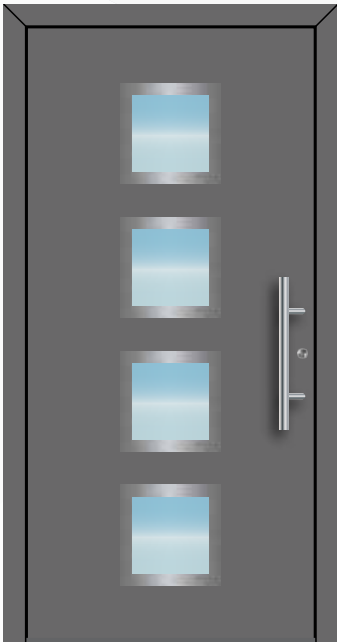

260

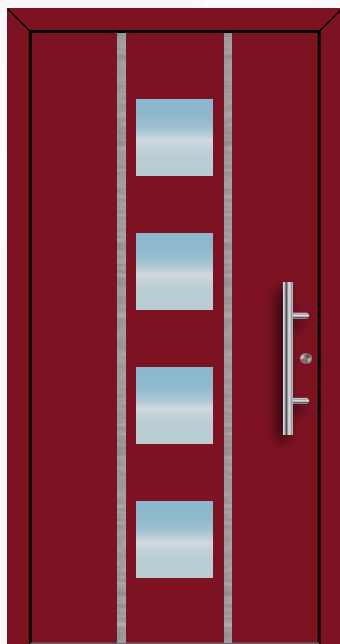

261

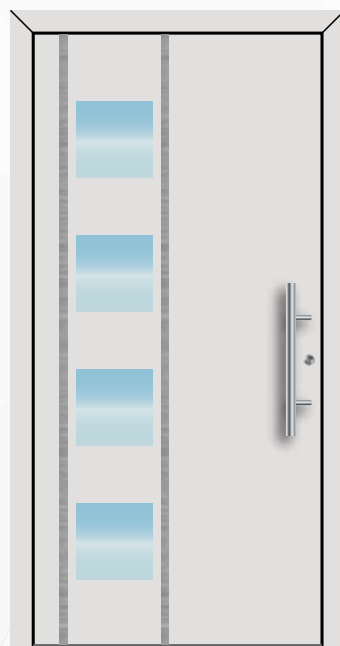

262

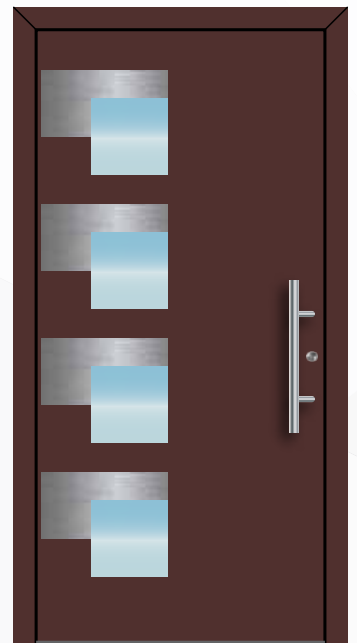

263

* you can modify existing or create your own door design



264

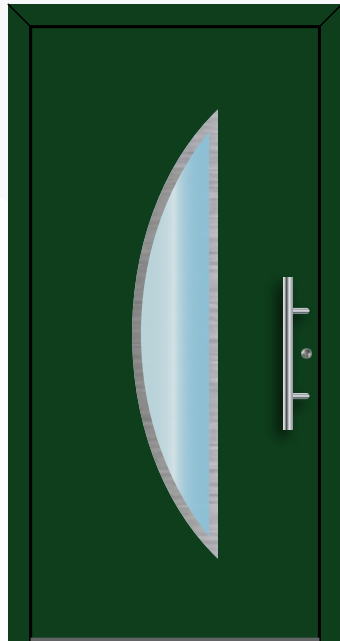

265

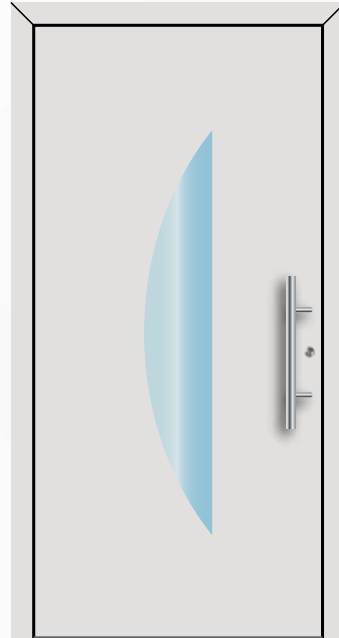

266

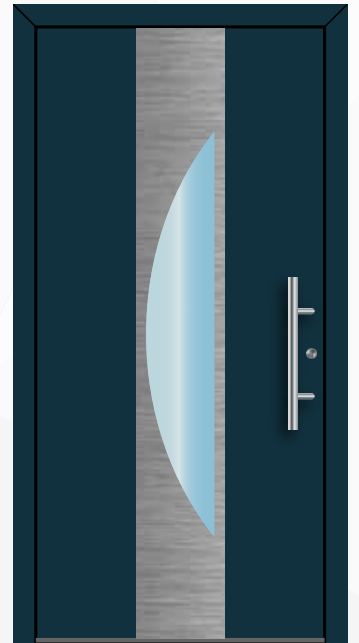

267

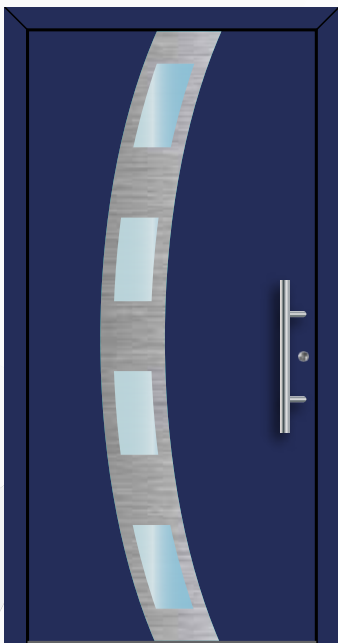

272

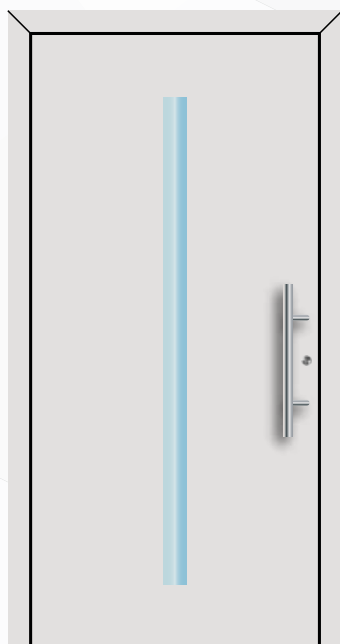

273

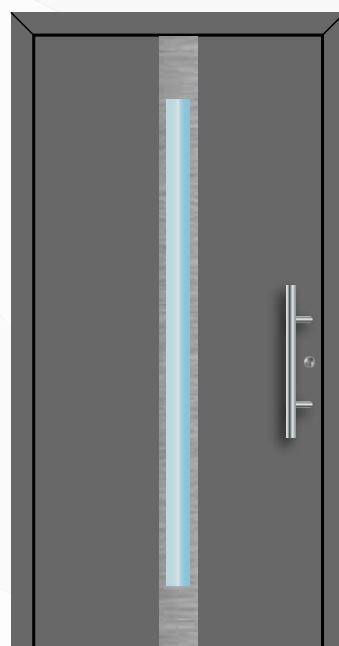

274

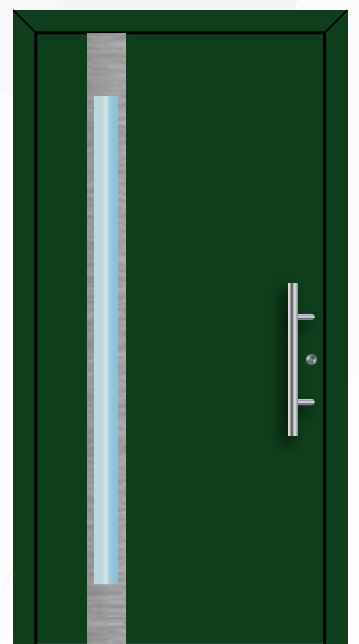

275

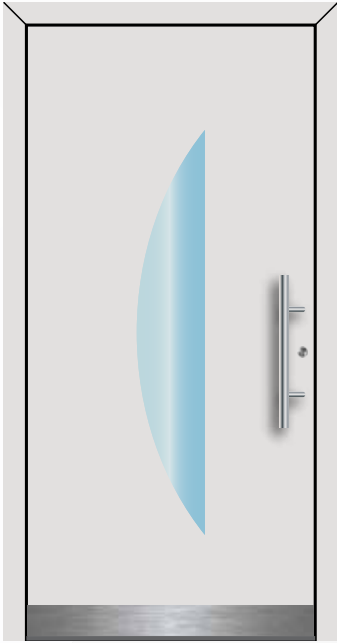

268

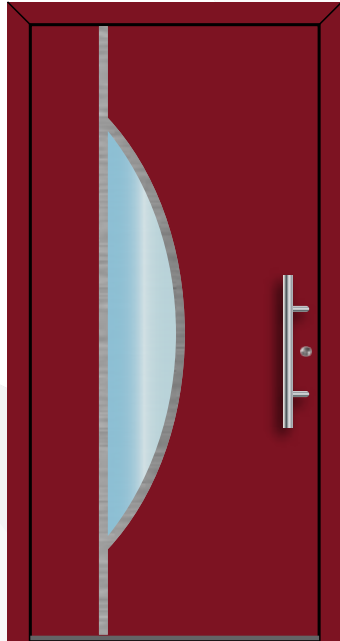

269

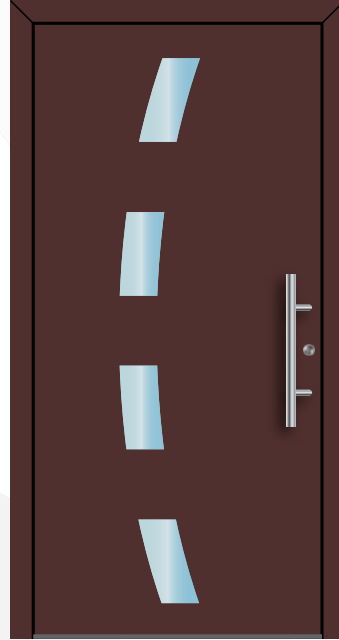

270

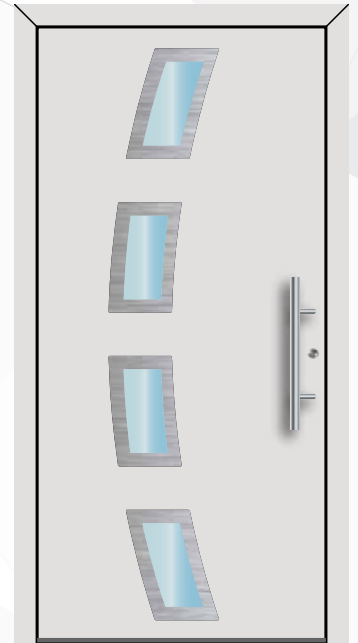

271

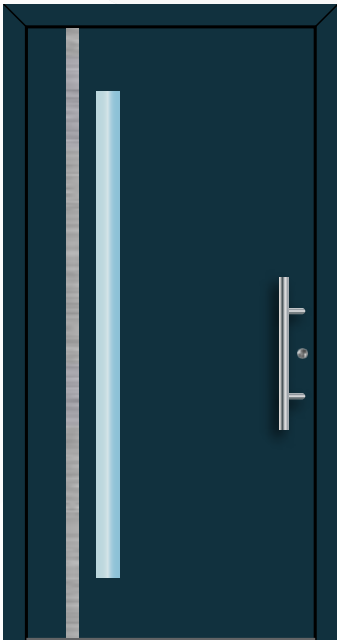

276

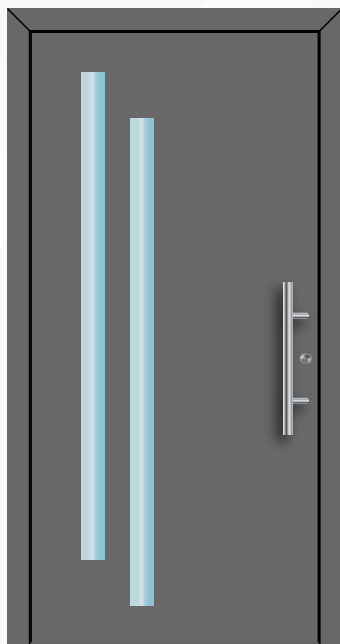

277

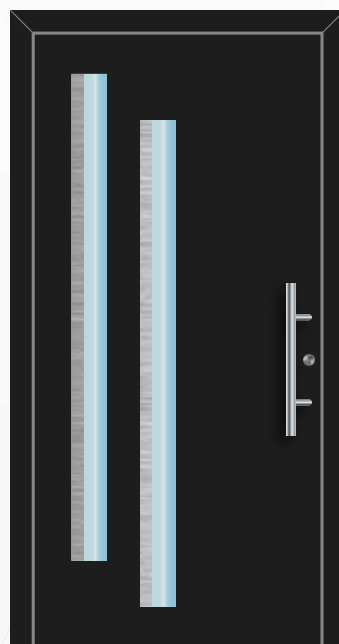

278



279

* you can modify existing or create your own door design

release date:
30.07.2018

